

Quick Service

Quick Service

Ihr Event steht kurz bevor - für die perfekte Firmenfeier fehlt Ihnen noch die repräsentative Bekleidung? Kein Problem !

Nutzen Sie unseren neuen, individuellen Service.

Sechs verschiedene Stoffqualitäten, 12 Modell-Varianten und 14 trendige Farben haben wir für Sie stets eingelagert.

Stellen Sie einfach Ihre Wunschkombination zusammen, Logo drauf - fertig !

| Artikel | Lieferzeit | Gewicht | Material |
|------------|------------|-----------------------|---------------------------------|
| T-shirt | 4-6 Wochen | 160 gr/m ² | 100% Baumwolle |
| Poloshirt | 4-6 Wochen | 210 gr/m ² | 50% Baumwolle/ 50% Polyester |
| Sweater | 4-6 Wochen | 280 gr/m ² | 50% Baumwolle/ 50% Polyester |
| Rugbyshirt | 4-6 Wochen | 240gr/m ² | 100 % Baumwolle |
| Fleece | 4-6 Wochen | 280gr/m ² | 100 % Polyester |
| Overhemd | 4-6 Wochen | 120 gr/m ² | 60% Baumwolle/ 40% Polyester |



Quick Service















Inhalt

| | |
|------------------------------------|----|
| Farben..... | 3 |
| Details..... | 4 |
| Techniken | 6 |
| Arbeitsweise..... | 7 |
| T-shirts | |
| S.TSM.01 | |
| Santino T-shirt Herren..... | 8 |
| S.TSL.01 | |
| Santino T-shirt Damen | 10 |
| Poloshirts | |
| S.PSM.01 | |
| Santino Poloshirt Men | 12 |
| S.PSL.01 | |
| Santino Poloshirt Ladies | 14 |
| Sweaters | |
| S.SWU.01 | |
| Santino Sweater Unisex | 16 |
| S.RSU.01 | |
| Santino Rugbyshirt Unisex..... | 18 |
| S.HSU.01 | |
| Santino Hooded Sweater Unisex..... | 20 |
| Shirts | |
| S.SHM.01 | |
| Santino Shirt Herren..... | 22 |
| S.SHL.01 | |
| Santino Shirt Damen..... | 24 |
| Polarfleece | |
| S.FJM.01..... | |
| Santino Fleece Jack Herren | 26 |
| S.FJL.01 | |
| Santino Fleece Jack Damen | 28 |







Quick Service

Kleuren













Farben Jersey / Piqué / American Knit

| | | |
|---|--------------------|--------------------|
|  | Schwarz..... | Schwarz |
|  | Weiß | Weiß |
|  | Marine | PMS 296 |
|  | Dunkel Grün | PMS 5535 |
|  | Blau..... | PMS 288 |
|  | Rot..... | PMS 187 |
|  | Dunkel Grau | PMS Dunkel Grau 11 |
|  | Bordeaux | PMS 7428 |
|  | Lime Grün..... | PMS 382 |
|  | Sand | PMS 7502 |
|  | Gelb..... | PMS 116 |
|  | Orange..... | PMS 021 |
|  | Lichtblau..... | PMS 278 |
|  | Grau Melange | PMS 427 |







Farben Polarfleece

| | | |
|---|------------------|-----------------|
|  | Sand | PMS 7504 |
|  | Licht Blau | PMS 651 |
|  | Grün..... | PMS 567 |
|  | Rot..... | PMS 201 |
|  | Schwarz..... | Schwarz |
|  | Antrazit..... | PMS Antrazit 11 |
|  | Marine | PMS 296 |

Farben Poplin.....

| | | |
|---|-------------------|-----------------|
|  | Weiß | Weiß |
|  | Sand | PMS 452 |
|  | Gelb..... | PMS 7406 |
|  | Dunkel Grau | PMS 416 |
|  | Rot..... | PMS 200 |
|  | Bordeaux | PMS 505 |
|  | Licht blau..... | PMS 543 |
|  | Blau..... | PMS 660 |
|  | Marine | PMS 534 |
|  | Grau..... | PMS Warm Grau 1 |
|  | Schwarz..... | Schwarz |
|  | Rose..... | PMS 496 |

Farben Oxford.....

| | | |
|---|------------------|---------|
|  | Weiß | Weiß |
|  | Rot..... | PMS 200 |
|  | Orange..... | PMS 165 |
|  | Licht Blau | PMS 277 |
|  | Marine | PMS 296 |
|  | Schwarz..... | Schwarz |
|  | Rose..... | PMS 496 |

Quick Service

Details

* Kragen

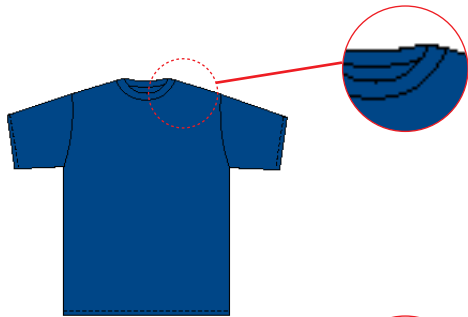

▲ Kragen in derselben Farbe wie T-shirt

* Kragen

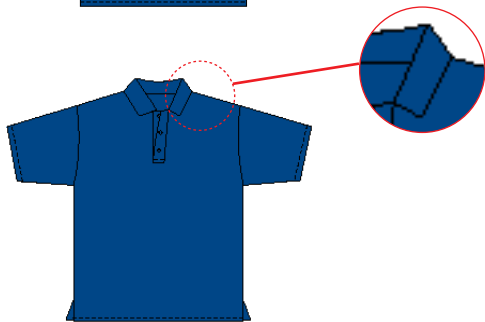

▲ Kragen in derselben Farbe wie Poloshirt

* Kragen

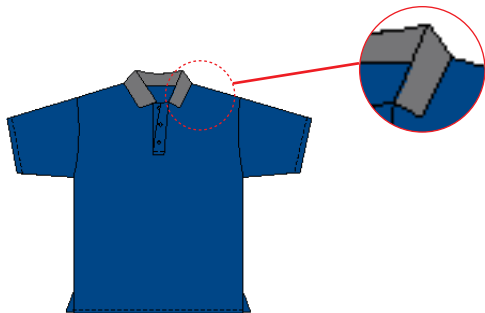

▲ Kragen in anderer Farbe

* Tipping

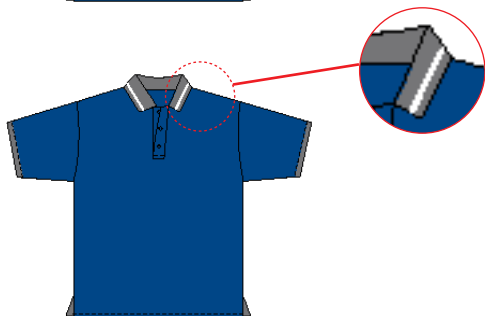

▲ Mit Streifen am Kragen, in verschiedenen Farben kombinierbar

* Kc

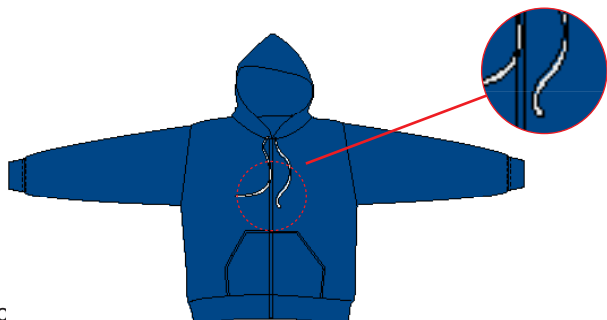

▲ Mit Kordelen kombinierbar

Details

* Ärmel

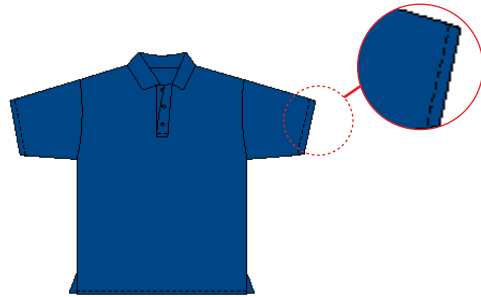

▲ Ärmel in der gleichen Farbe

* Ärmel

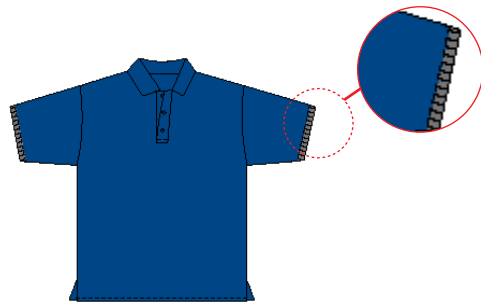

▲ Ärmel in einer anderen Farbe

* Ärmel

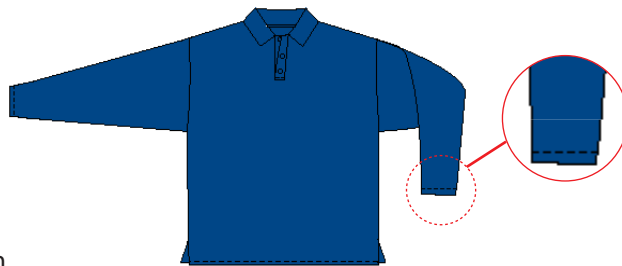

▲ Ärmel in der gleichen Farbe (Langarm)

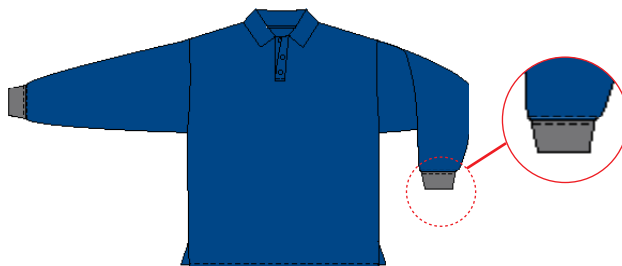

▲ Ärmel in der gleichen Farbe (Langarm)
▲ Ärmelbund gerippt

Quick Service

Techniken



▲ Stick

Die klassische Variante.
Dieses Veredelungstechnik ist im wahrsten Sinne des Wortes edel.
Selbst kleinste bestickte Flächen werten Ihr Produkt auf.

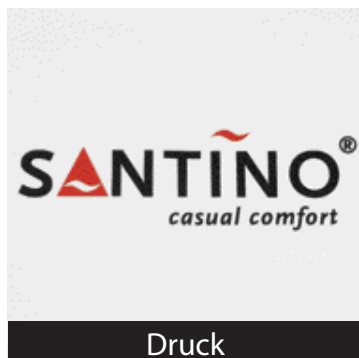

▲ Druck

Schnell und günstig!
Besonders geeignet für den großflächigen Einsatz, bietet aber auch in kleiner Form sehr hohe Qualität.
Unsere wasserbasierte Textildruckfarbe zeichnet sich durch einen guten Stoffgriff aus und ist selbstverständlich überbügelnbar.

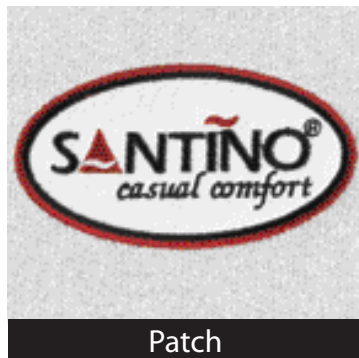

▲ Patch

Digitale Umsetzung und Ausdruck auf Spezialpapier bzw Stoff.
Wird anschließend auf das Textil transferiert bzw gestickt.
Eigenschaften: Hochwärtige Art, Textilien zu veredeln.

Arbeitsverfahren

Jede Anfrage zu Santino Custom Choice beginnt mit einem Entwurf. Dieser Entwurf wird in enger

Zusammenarbeit mit dem Auftraggeber erstellt. Alle Kriterien werden hierbei berücksichtigt: Qualität,

Farben (der Hausstile), Maßschemen, Logos, Labels, Knöpfe, Details, Lieferzeit und Budget.

Nach Genehmigung der Zeichnungen werden Ihnen die Farbmuster, Materialien und gegebenenfalls

die Labels, Knöpfe und andere Kennzeichen zur Akzeptanz vorgelegt.

Nach der endgültigen Akzeptanz startet letztendlich die Produktion und die Lieferzeit steht fest.



Poloshirt vorzijde



Poloshirt achterzijde



Badlaken Jacquardinweef



Poloshirt vorzijde



Poloshirt achterzijde

Quick Service

T-shirts

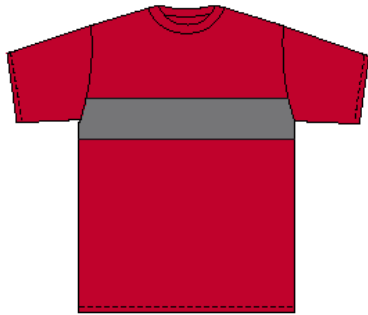

S.TSM.01

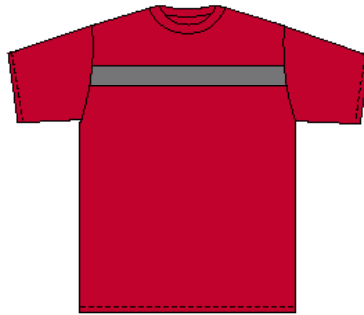

S.TSM.02

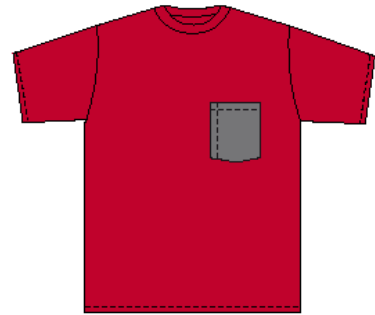

S.TSM.03

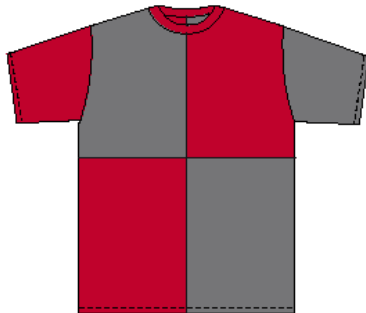

S.TSM.04

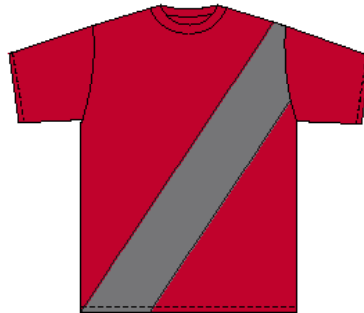

S.TSM.05

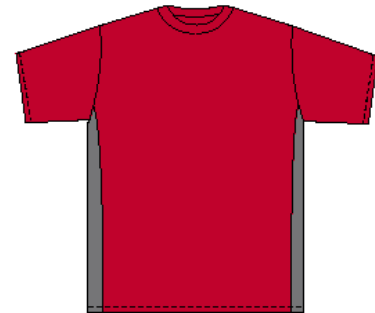

S.TSM.06

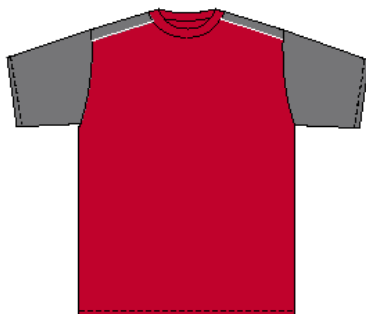

S.TSM.07



S.TSM.08

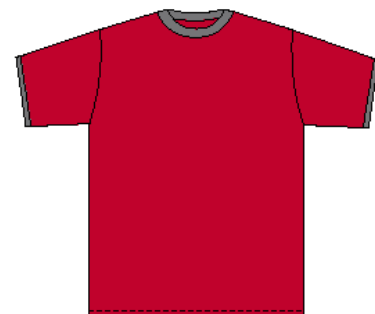

S.TSM.09

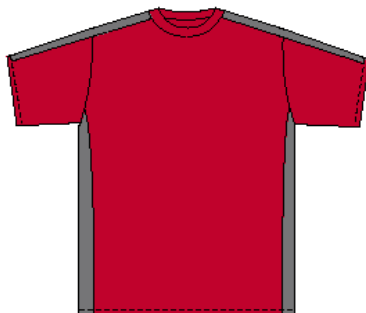

S.TSM.10

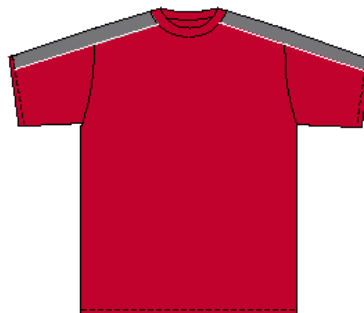

S.TSM.11

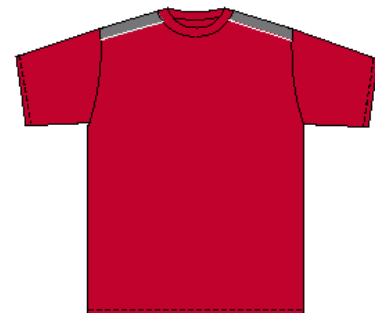

S.TSM.12

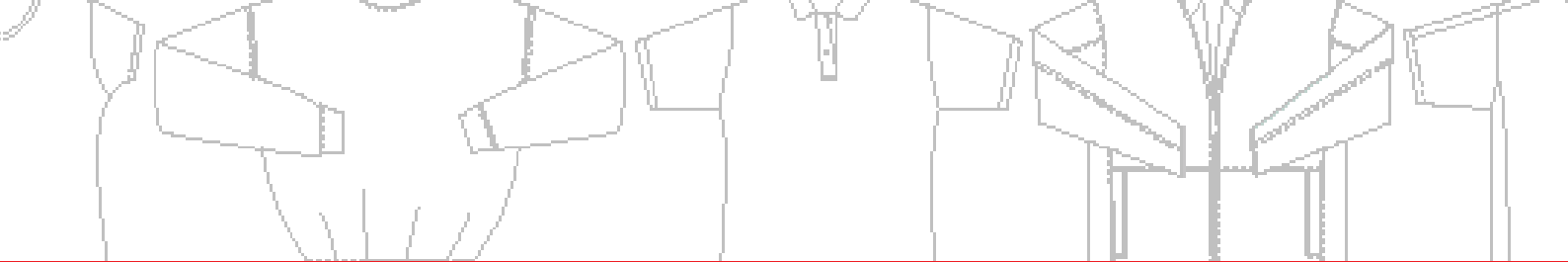

Nacken Optik

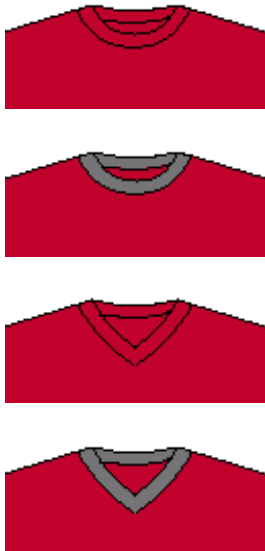

Ärmel Optik

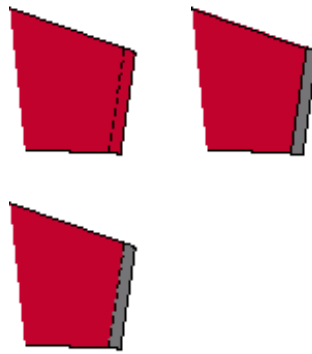

Ärmel Optik

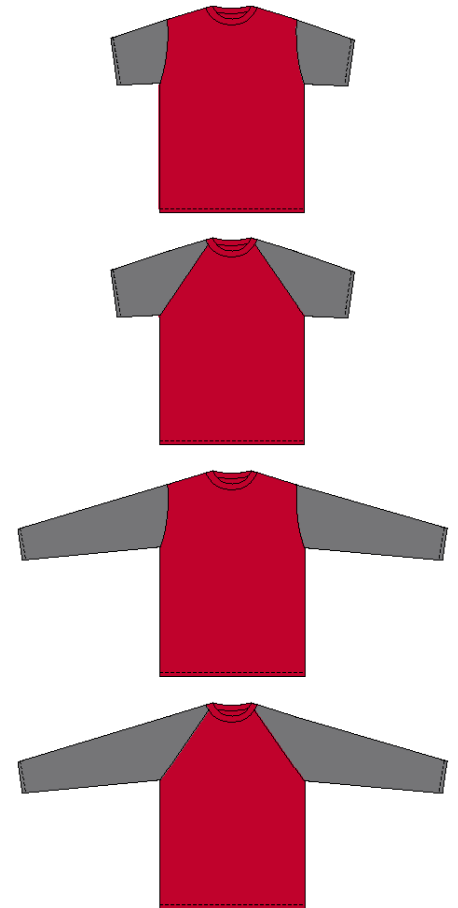

Bund Optik

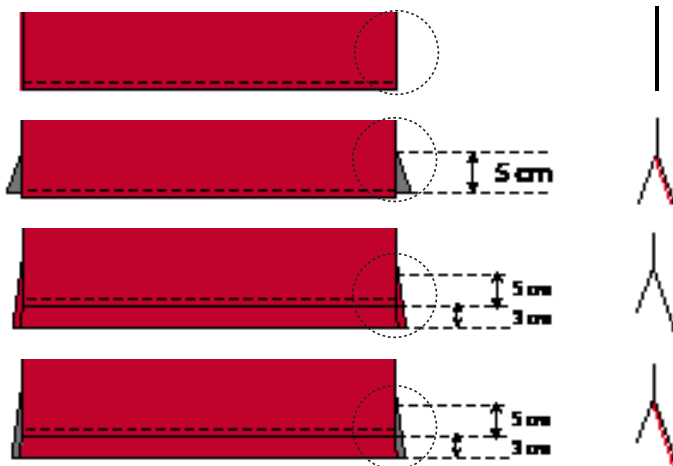

Farben



Quick Service

T-shirts Ladies

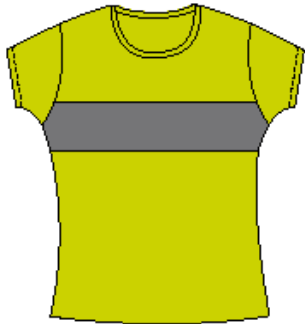

S.TSL.01

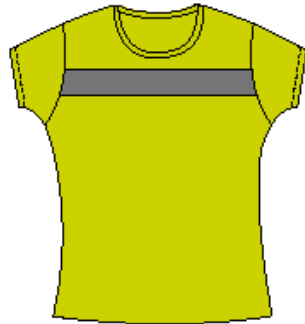

S.TSL.02

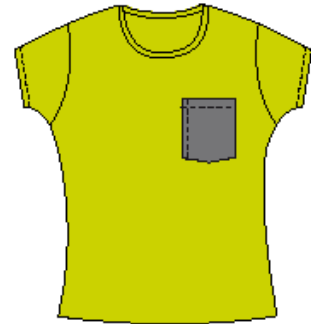

S.TSL.03



S.TSL.04



S.TSL.05



S.TSL.06



S.TSL.07

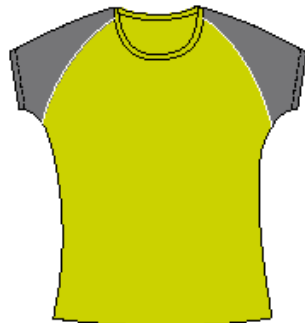

S.TSL.08

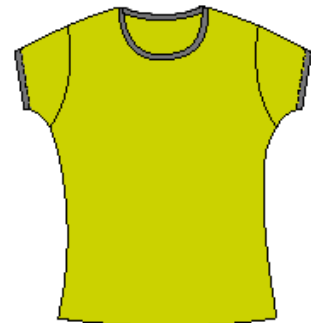

S.TSL.09



S.TSL.10

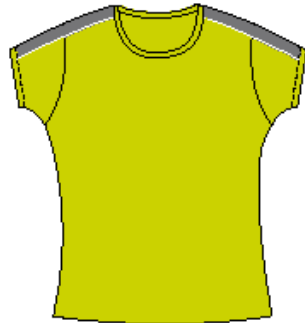

S.TSL.11

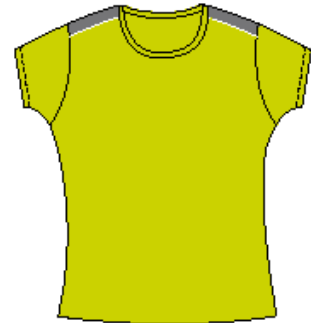

S.TSL.12

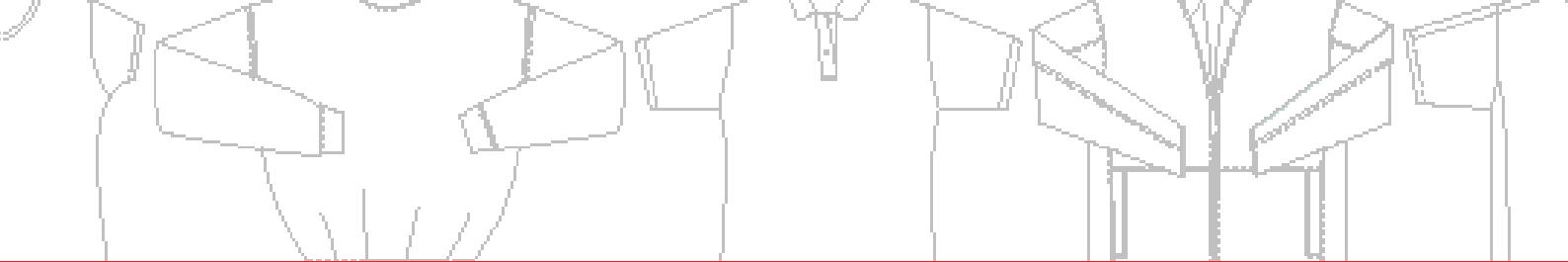

Nacken Optik

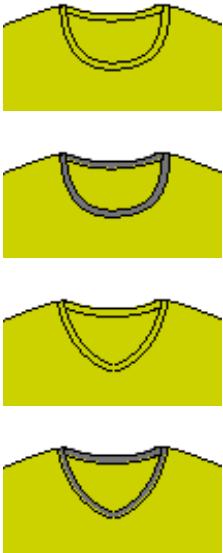

Ärmel Optik

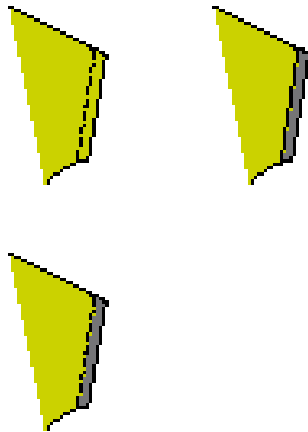

Ärmel Optik

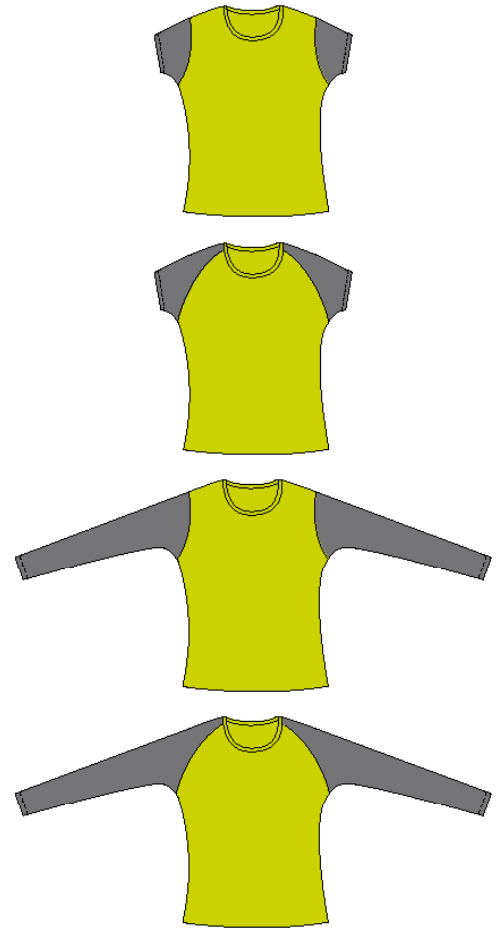

Bund Optik

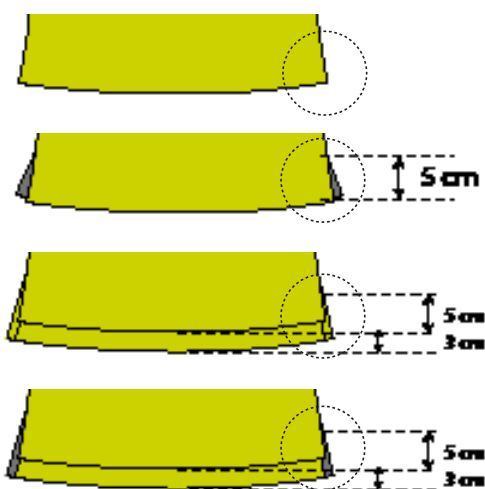

Farben

| | | | |
|-------------|----------|--------|------------|
| black | white | navy | dark green |
| cobalt blue | red | grey | bordeaux |
| lime | sand | yellow | orange |
| light blue | ash grey | | |

Quick Service

Poloshirts



S.PSM.01



S.PSM.02

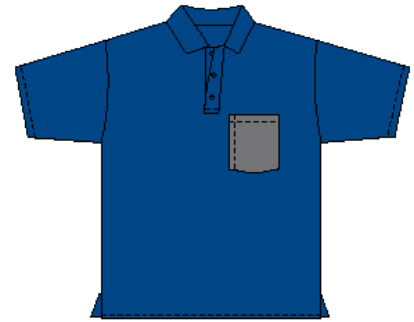

S.PSM.03



S.PSM.04



S.PSM.05



S.PSM.06



S.PSM.07



S.PSM.08



S.PSM.09



S.PSM.10



S.PSM.11



S.PSM.12

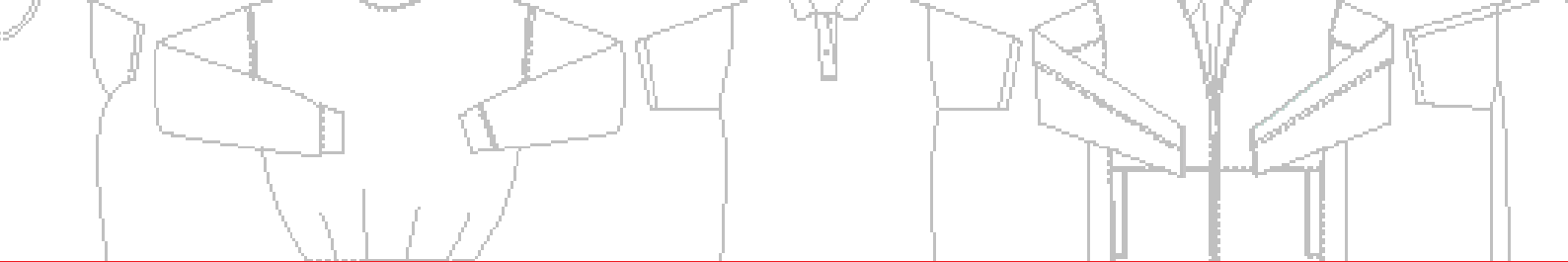

Nacken Optik



Ärmel Optik



Ärmel Optik



Bund Optik



Farben

| | | | |
|-------------|----------|--------|------------|
| black | white | navy | dark green |
| cobalt blue | red | grey | bordeaux |
| lime | sand | yellow | orange |
| light blue | ash grey | | |

Quick Service

Poloshirts Ladies

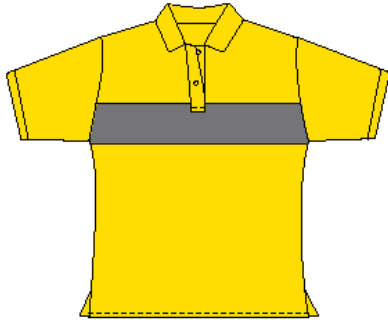

S.PSL.01

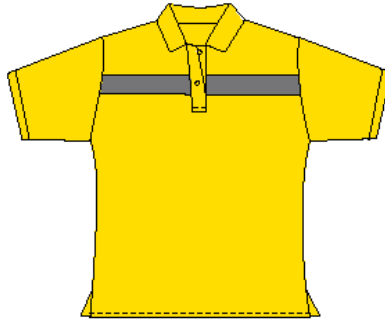

S.PSL.02

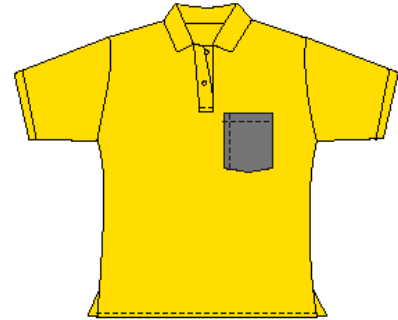

S.PSL.03

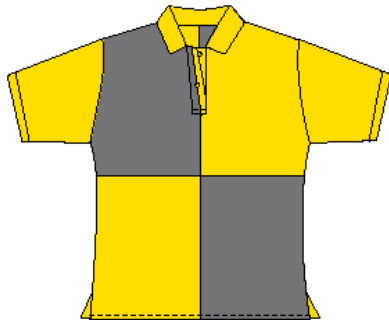

S.PSL.04



S.PSL.05

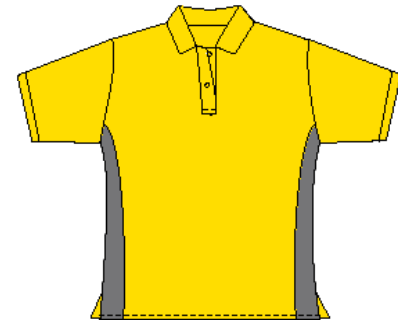

S.PSL.06



S.PSL.07



S.PSL.08

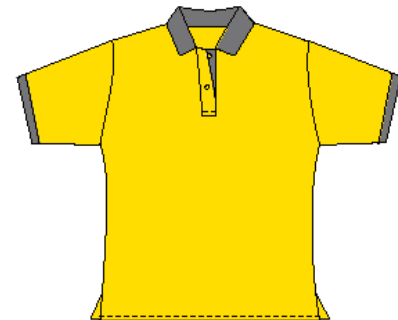

S.PSL.09

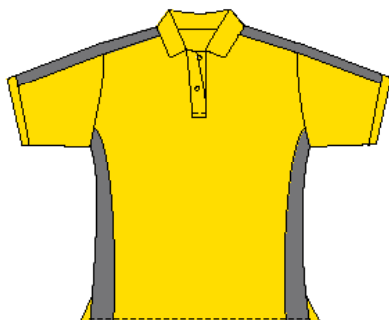

S.PSL.10

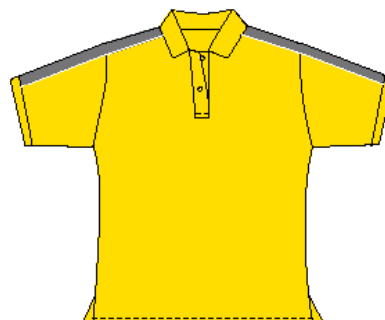

S.PSL.11

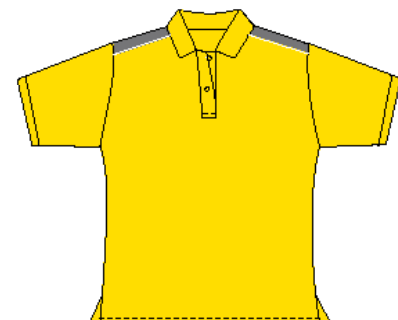

S.PSL.12

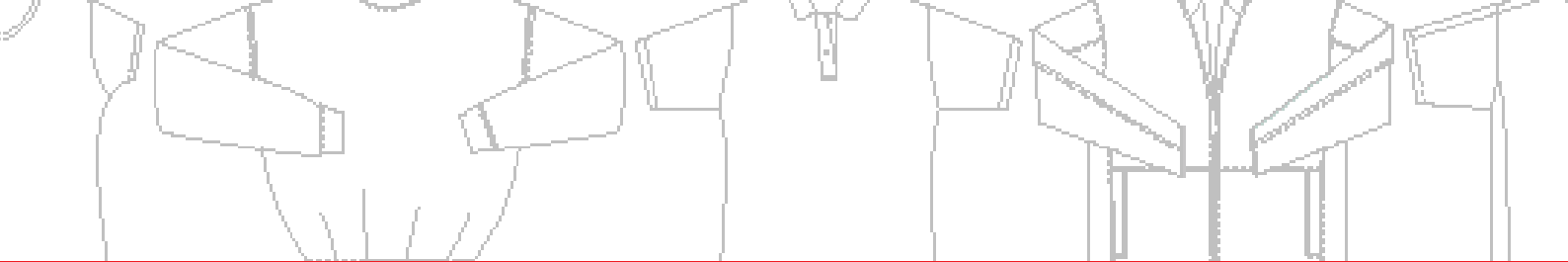

Nacken Optik

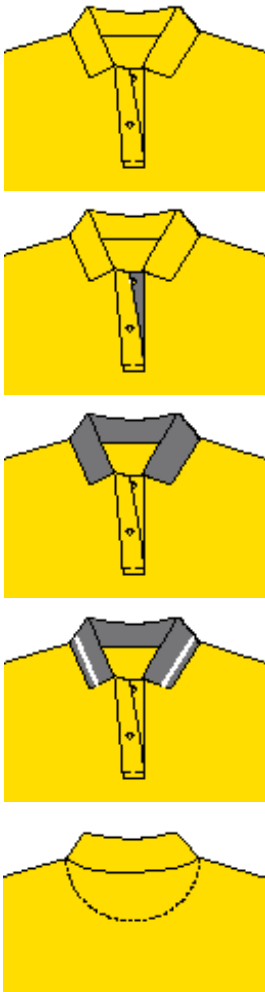

Ärmel Optik



Ärmel Optik

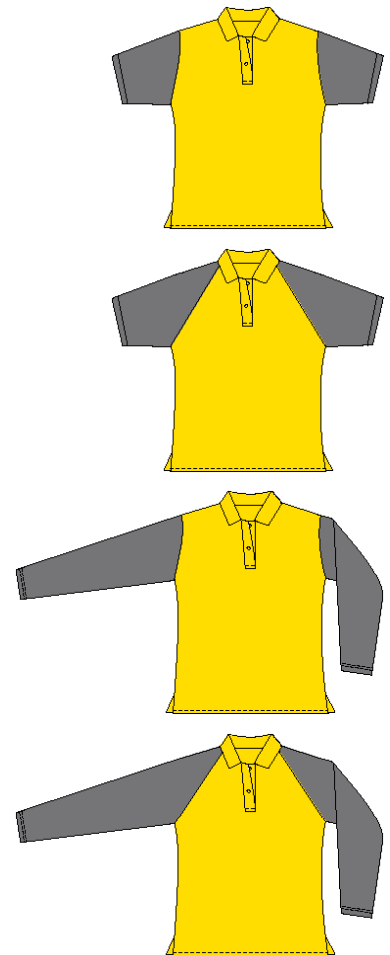

Bund Optik

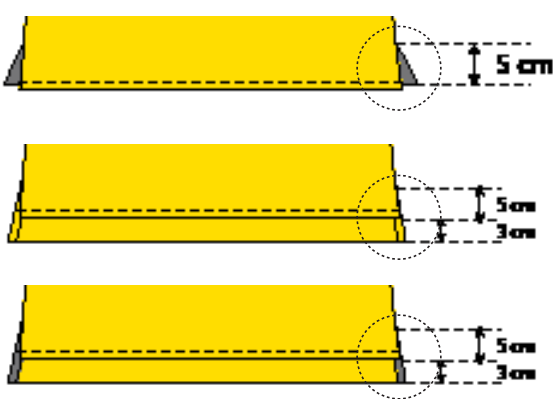

Farben

| | | | |
|-------------|----------|--------|------------|
| black | white | navy | dark green |
| cobalt blue | red | grey | bordeaux |
| lime | sand | yellow | orange |
| light blue | ash grey | | |

Quick Service

Sweaters

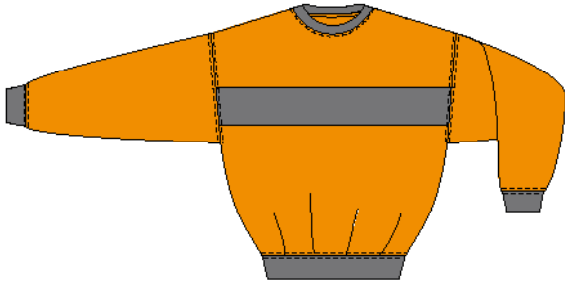

S.SWU.01

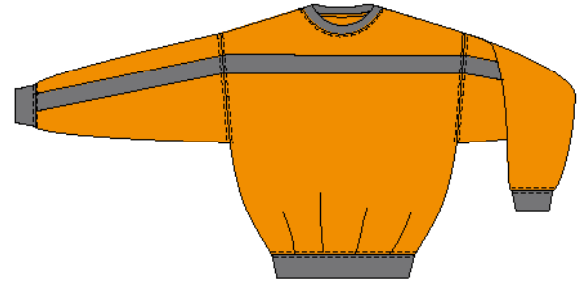

S.SWU.02

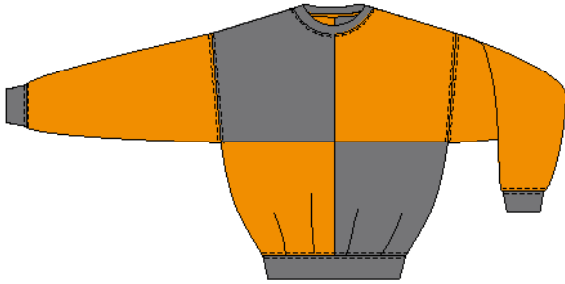

S.SWU.04

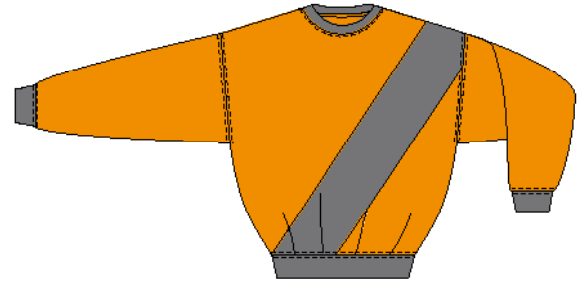

S.SWU.05

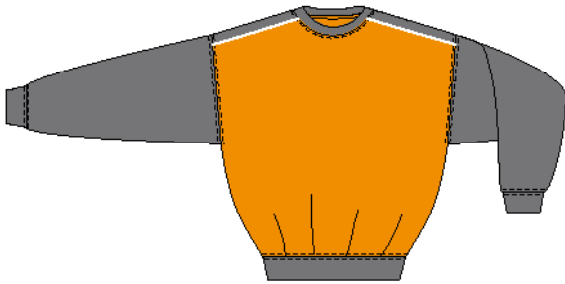

S.SWU.07

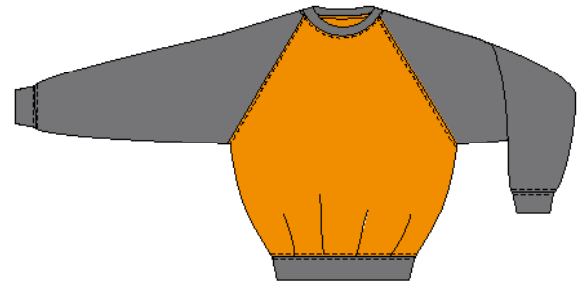

S.SWU.08

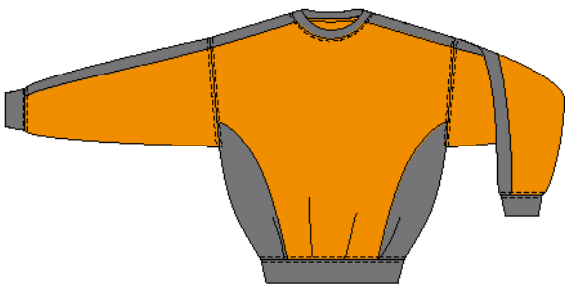

S.SWU.10

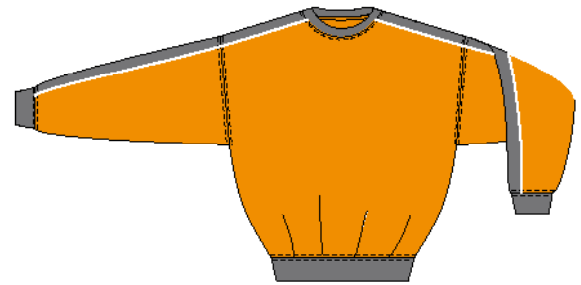

S.SWU.11



Nacken Optik

Bund Optik

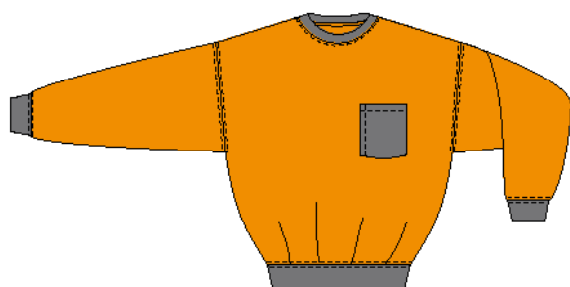

S.SWU.03



S.SWU.06

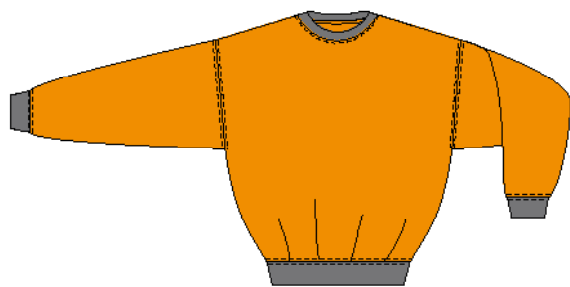

S.SWU.09

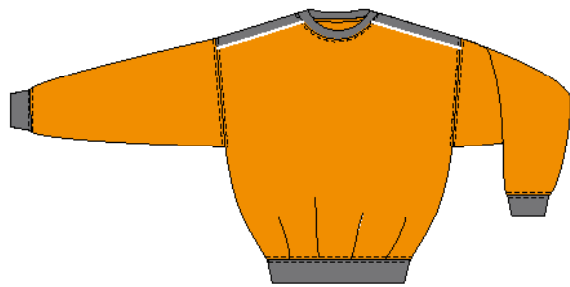

S.SWU.12



Ärmel Optik

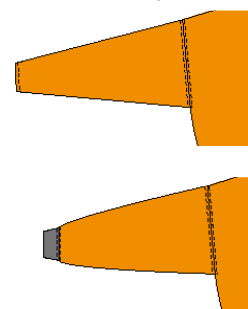

Farben

| | | | |
|-------------|----------|--------|------------|
| black | white | navy | dark green |
| cobalt blue | red | grey | bordeaux |
| lime | sand | yellow | orange |
| light blue | ash grey | | |

Quick Service

Rugbyshirts

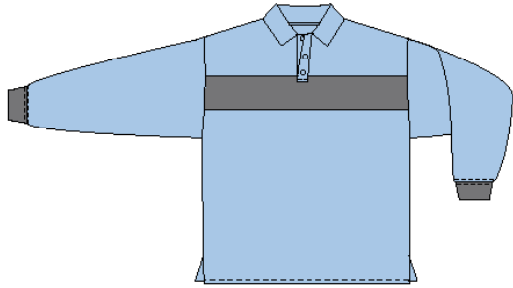

S.RSU.01

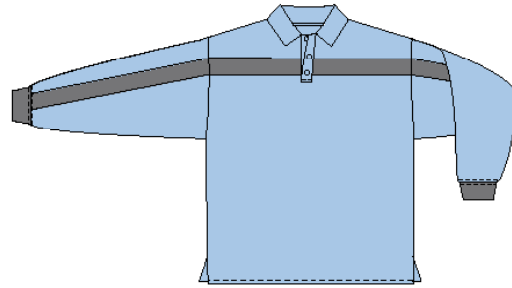

S.RSU.02

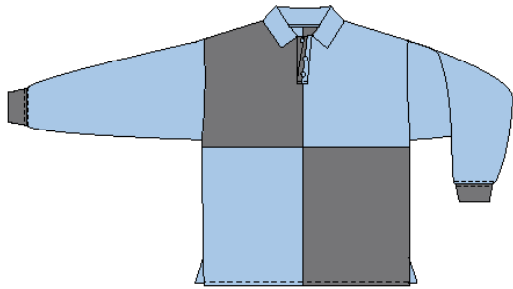

S.RSU.04

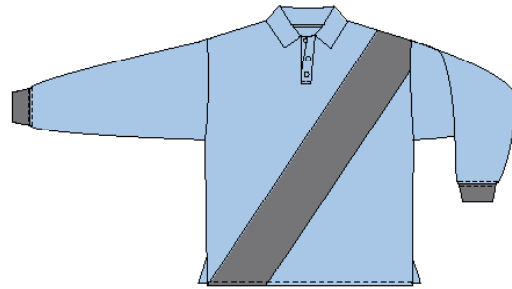

S.RSU.05

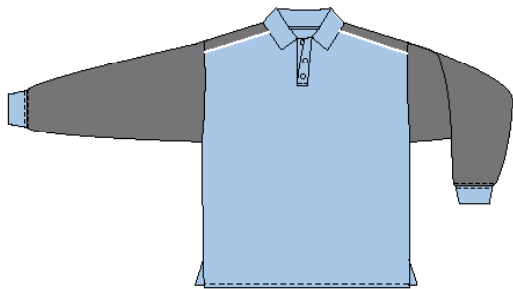

S.RSU.07

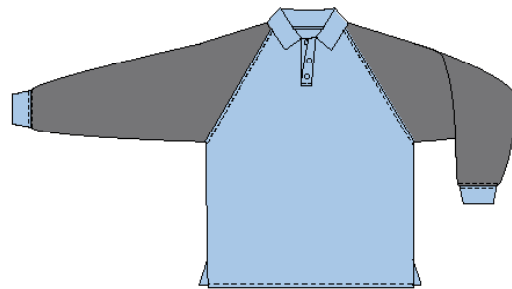

S.RSU.08

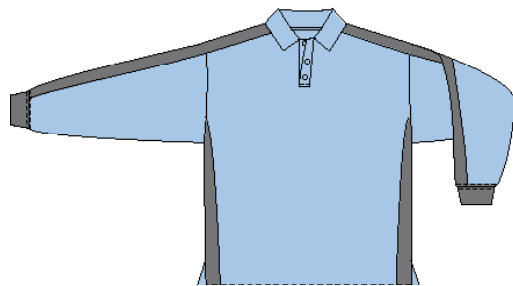

S.RSU.10

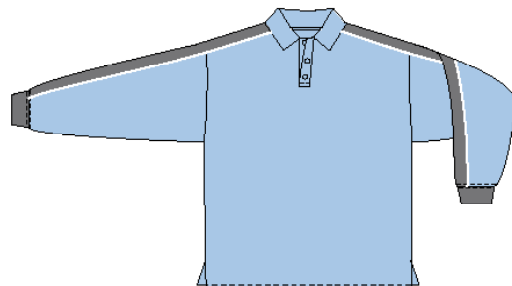

S.RSU.11

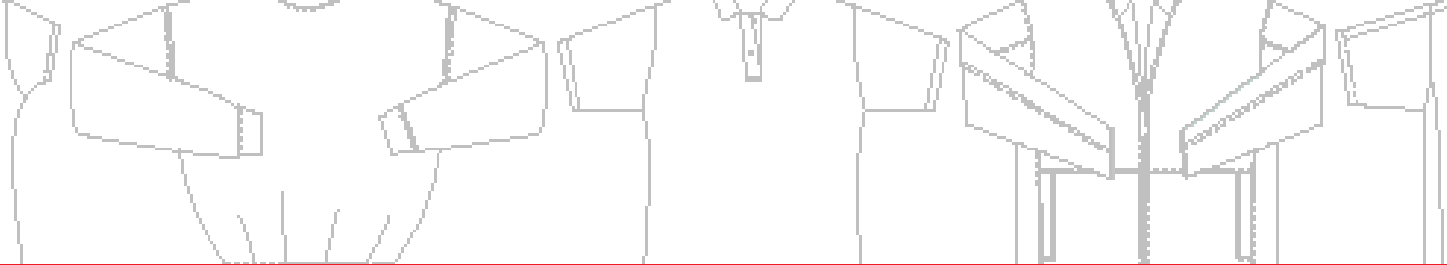

Nacken Optik

Bund Optik

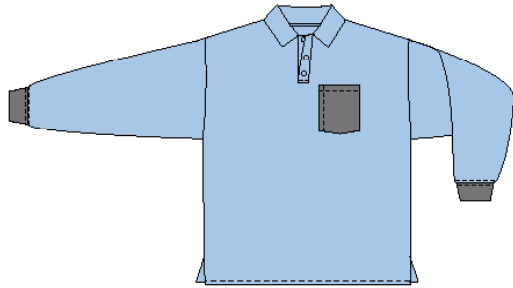

S.RSU.03

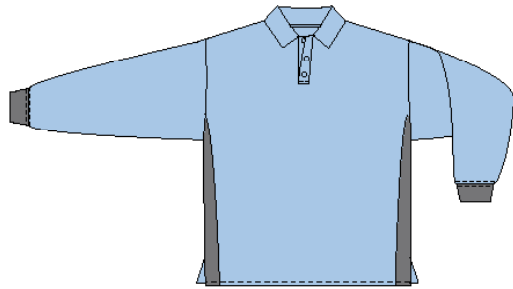
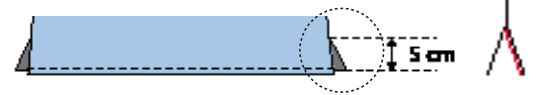

S.RSU.06

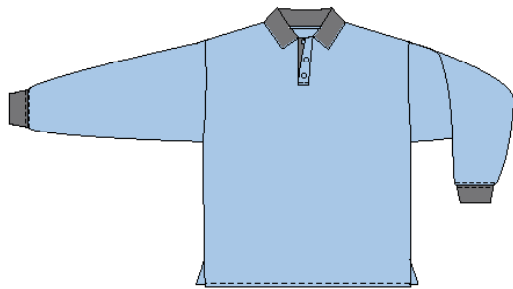
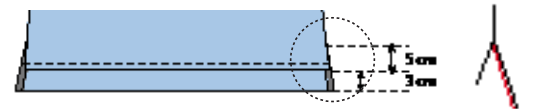
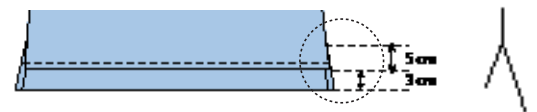

S.RSU.09

Ärmel Optik

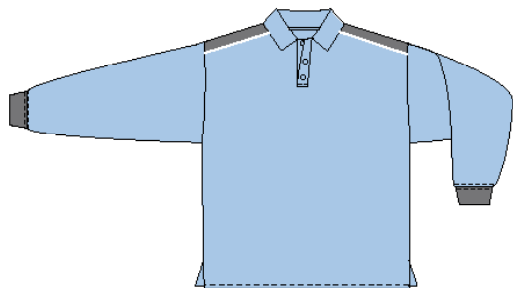
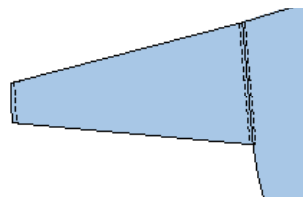

S.RSU.12

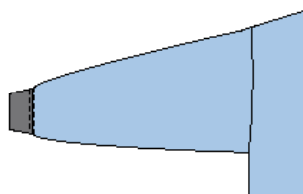

Farben

| | | | |
|-------------|----------|--------|------------|
| black | white | navy | dark green |
| cobalt blue | red | grey | bordeaux |
| lime | sand | yellow | orange |
| light blue | ash grey | | |

Quick Service

KaputzenSweaters



S.HSU.01



S.HSU.02



S.HSU.04



S.HSU.05



S.HSU.07



S.HSU.08



S.HSU.10



S.HSU.11

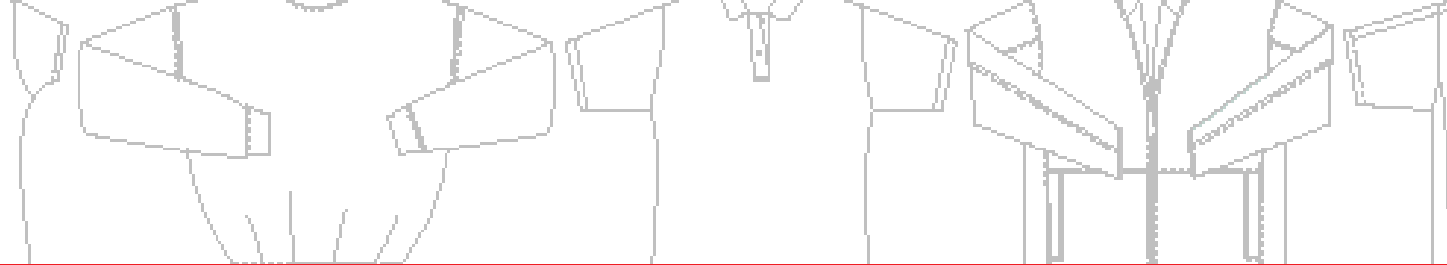

S.HSU.03



S.HSU.06



S.HSU.09



S.HSU.12

Kaputzen Optik



Bund Optik



Ärmel Optik



vorderseiten Optik

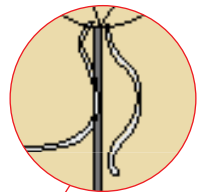
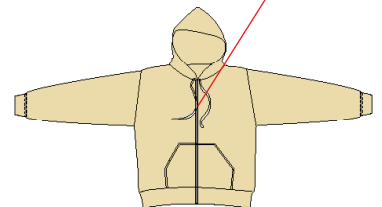

Farben

| | | | |
|-------------|----------|--------|------------|
| black | white | navy | dark green |
| cobalt blue | red | grey | bordeaux |
| lime | sand | yellow | orange |
| light blue | ash grey | | |

Quick Service

Shirts

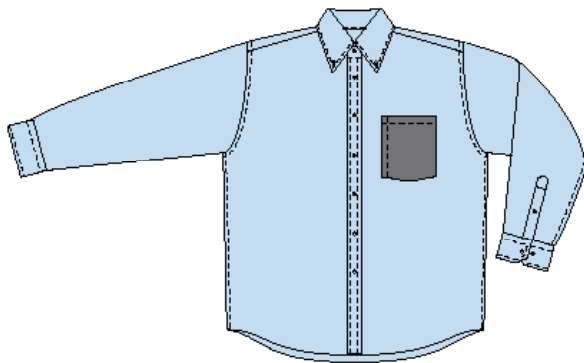

S.SHM.01

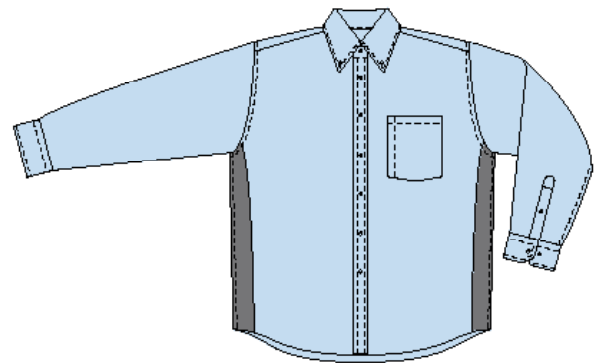

S.SHM.02

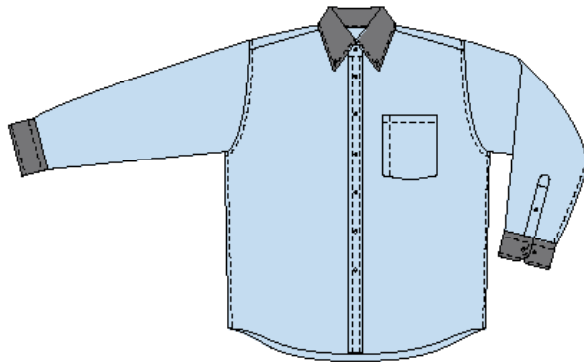

S.SHM.03

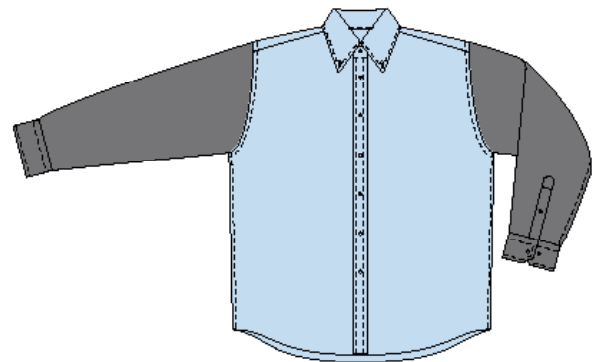

S.SHM.04

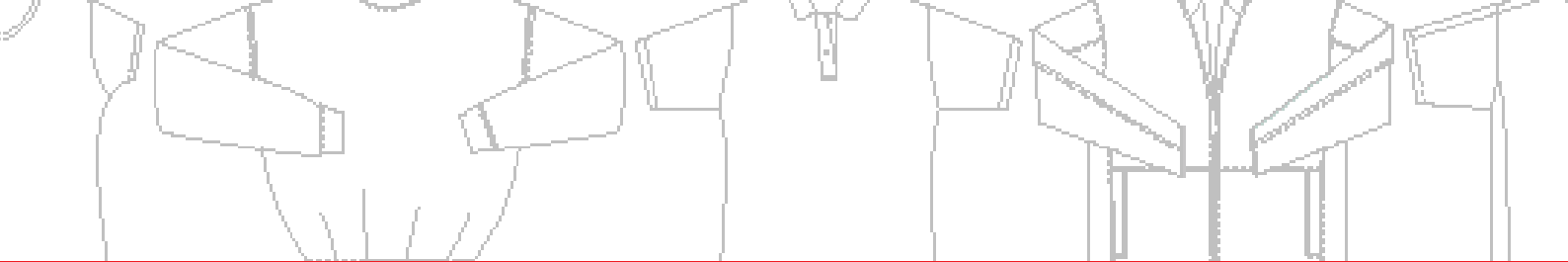

Ärmel Optik

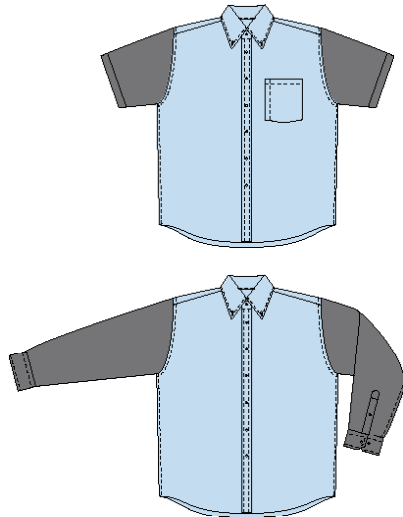

Brusttaschen Optik

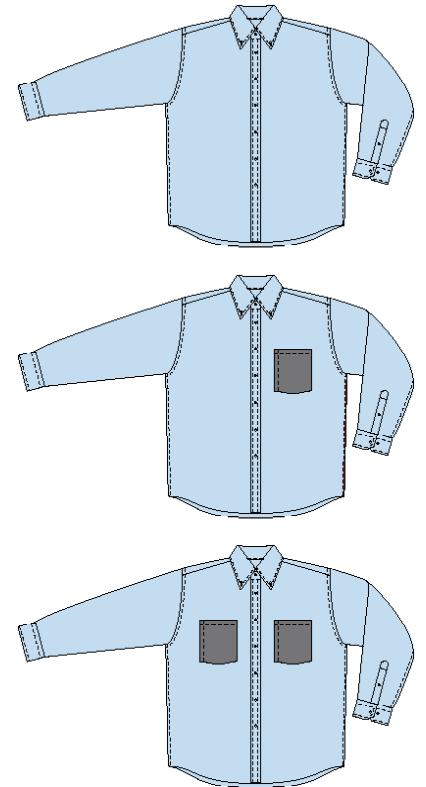

Farben

Oxford

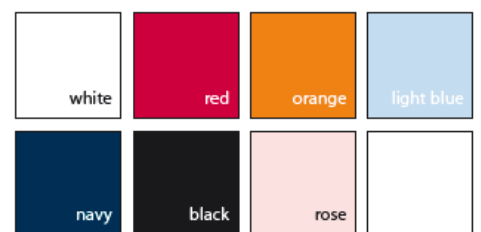

Poplin



Quick Service

Shirts Ladies

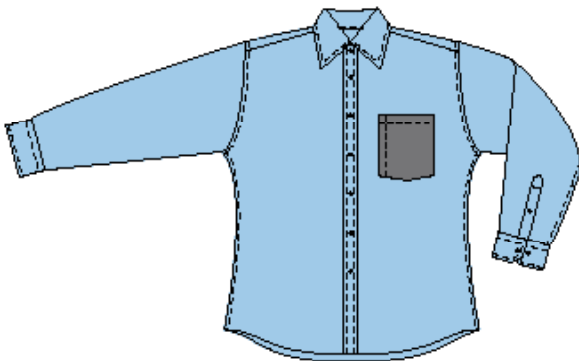

S.SHL.01

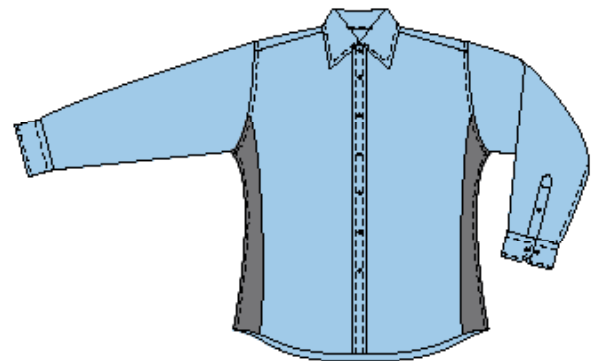

S.SHL.02

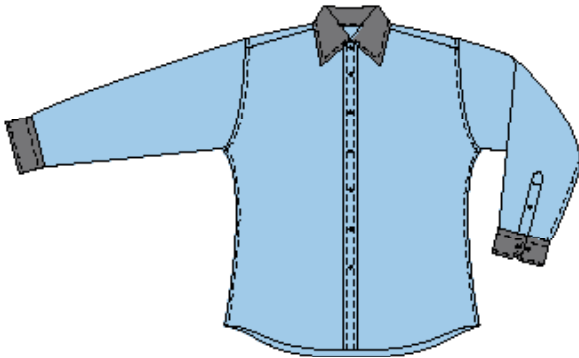

S.SHL.03

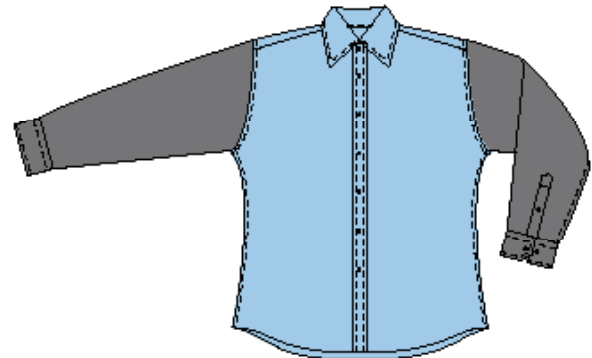

S.SHL.04

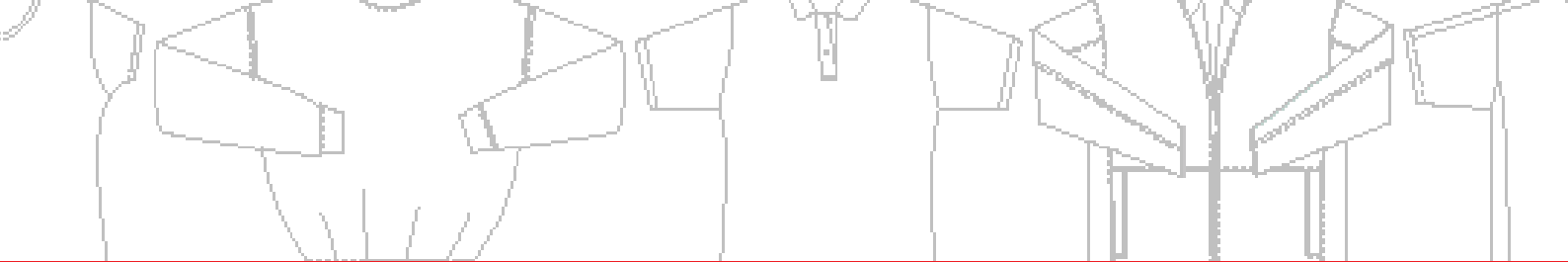

Ärmel Optik

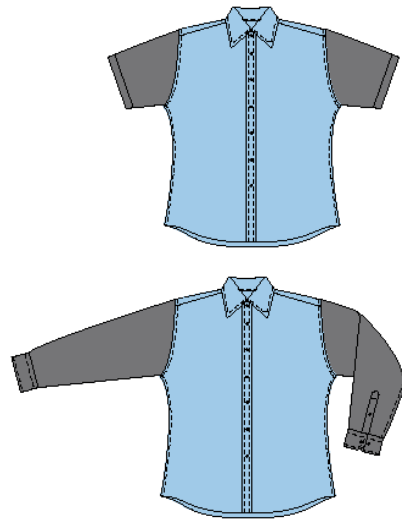

Brusttaschen Optik

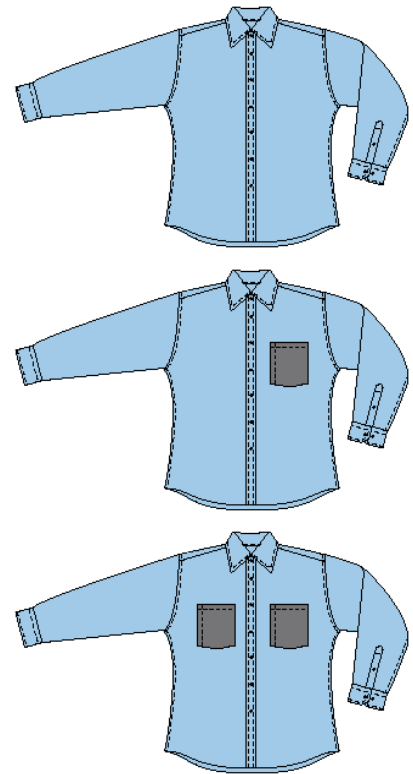

Farben

Oxford



Poplin



Quick Service

Polarfleece



Rückseite-optik 1

Rückseite-optik 2

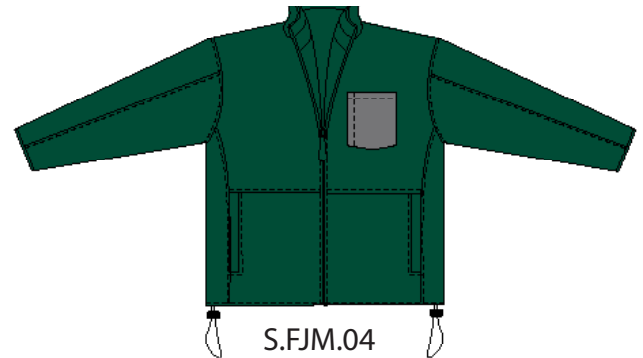
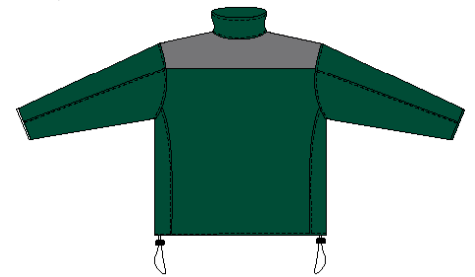

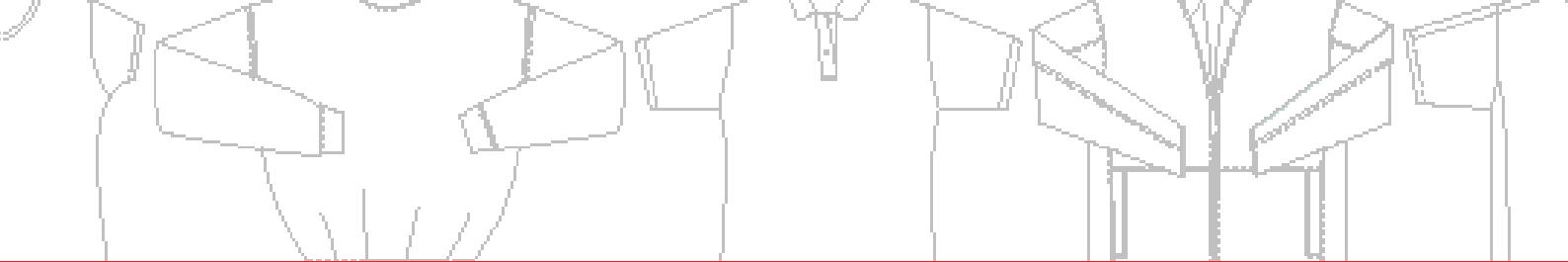

Reißverschluß Optik

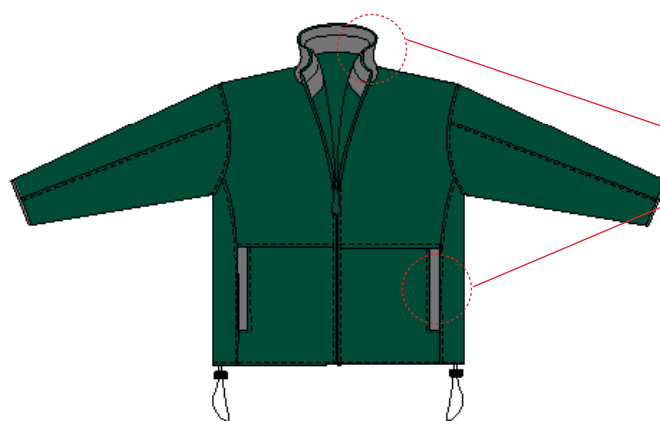
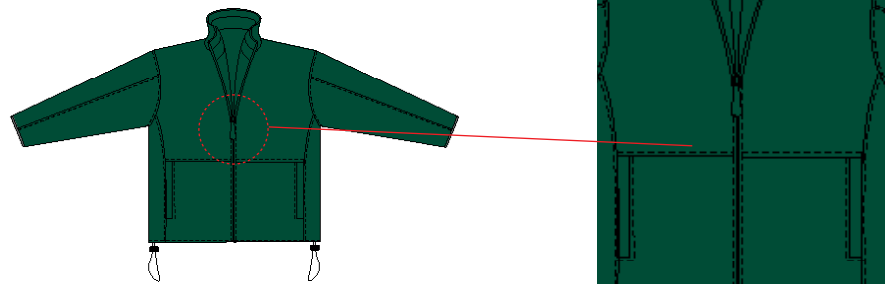
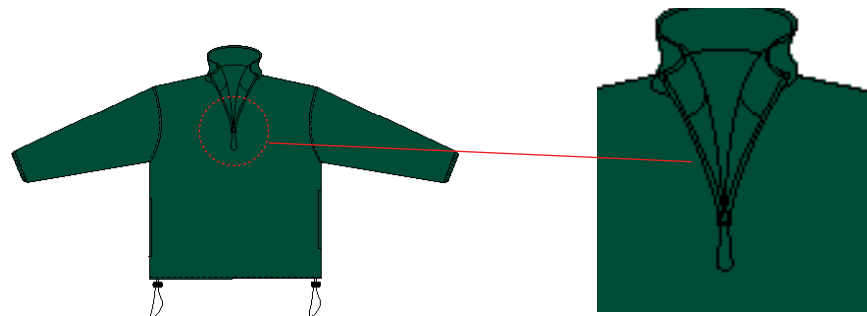

Möglichkeit in zwei verschiedenen Farben zu kombinieren.

Farben



Quick Service

Polarfleece Ladies



S.FJL.01



S.FJL.02

Rückseite-optik 1

Rückseite-optik 2



S.FJL.03



S.FJL.04



S.FJL.05



S.FJL.06

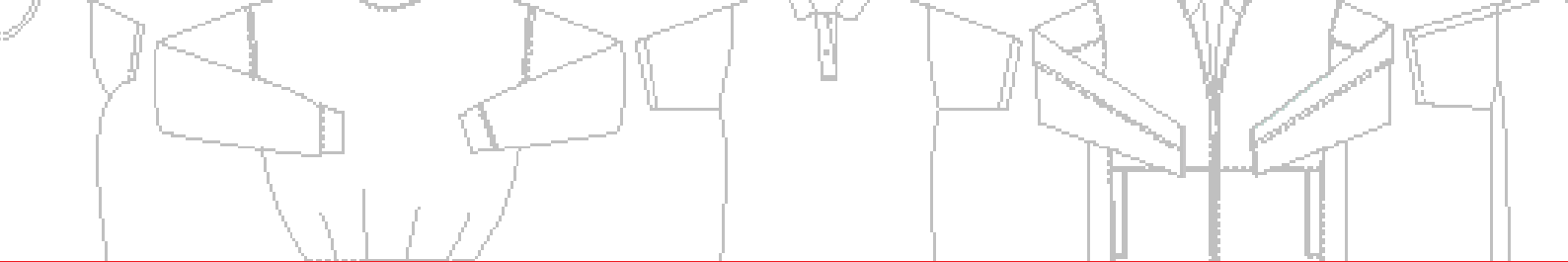

Reißverschluß Optik

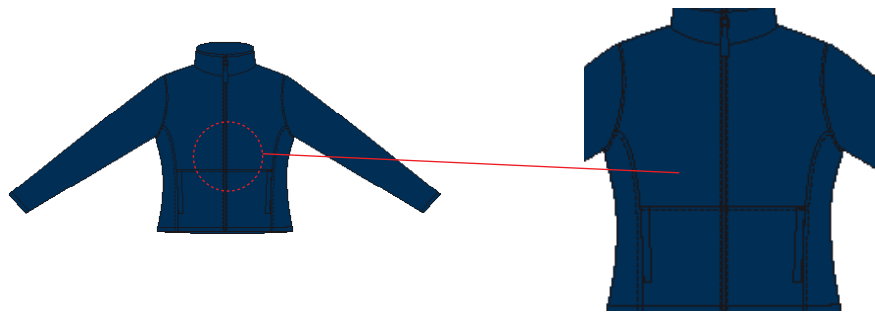
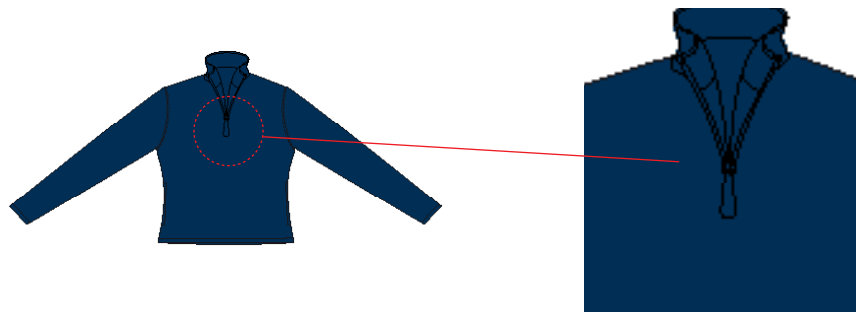

Möglichkeit in zwei verschiedenen Farben zu kombinieren.

Farben

